



www.solarnetco.com

SOLARNETTRAY

IT'S **SIMPLE** CABLE MANAGEMENT

BC1/BC2/BC5/BC6 Series

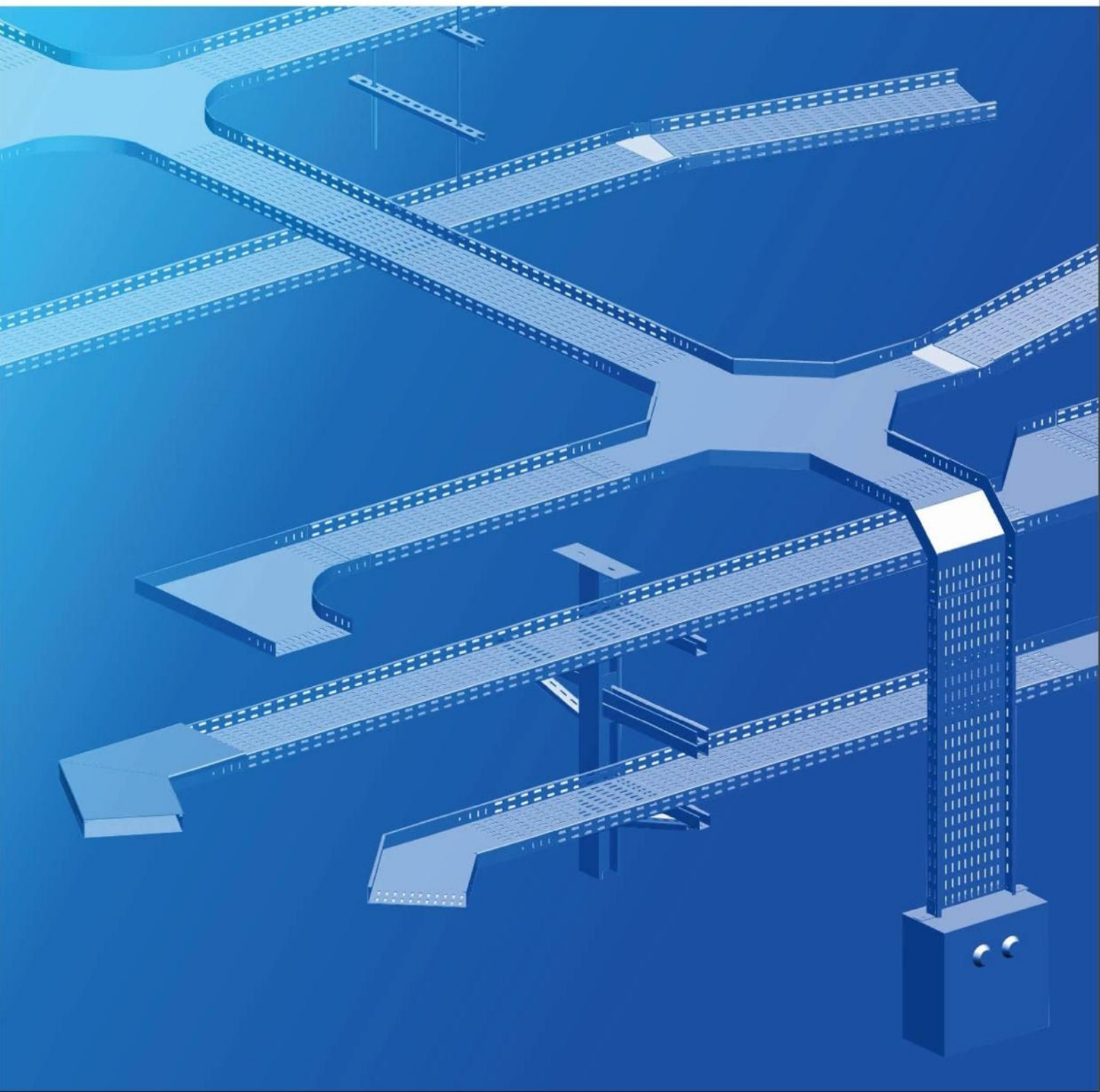



سینی کابل سولار:

سولار شبکه طیف گسترده ای از سینی های کابل پانچ شده را تولید می کند که با استفاده از ورق خام و ورق پیش گالوانیزه (GI). این سینی های کابل پانچ شده (سوراخدار) با انواع و قطرهای مختلف و عموماً از جنس ورق فولاد سرد ساخته می شوند..

سولار شبکه سینی های کابل پانچ شده خود را از نظر جنس ورق ، پوشش و مقاومت در برابر خوردگی در انواع ذیل در دسترس مشتریان قرار می دهد :

- G ***** Pre-galvanized steel
- H ***** Hot Dip Galvanized
- S۴ *** Stainless Steel SS۳۰۴
- A ***** Aluminium
- P ***** Powder Coated

هر قطعه سینی کابلی سوراخدار ما دارای طول متوسط ۲۰۰ الی ۳۰۰ سانتی متر است، ارائه طول های دیگر مورد نیاز مشتریان نیز بنا به سفارش امکان پذیر خواهد بود. همچنین سینی های کابل با قطر ورق مختلف و متنوع بنا بر نیاز و سفارش مشتری ارائه میگردد. علاوه بر این سولار شبکه مجموعه ای از لوازم جانبی مختلف که برای نصب سینی های کابل استفاده می شود را پشتیبانی می کند.

لوازم جانبی سینی کابل در سه گروه زیر ذکر شده است:

- ساپورت ها
- اتصالات
- بست ها

مزایای استفاده از سینی کابل:

- استحکام و ضریب ایمنی بالا در محافظت از کابل ها با استفاده از ورق های پانچ شده فولادی.
- قابلیت مدیریت و مرتب کردن کابل ها به نحوی که دسته بندی کابل ها با استفاده از سوراخ های پانچ شده روی بدنه سینی انجام می شود.
- محافظت از کابل ها در مقابل ضربات احتمالی ، صدمه به وسیله جوندگان و یا دسترسی های غیر مجاز و ...
- امکان تغییر مسیر و تغییر ارتفاع و تغییر مقطع با استفاده از قطعات جانبی مثل زانو ، سه راه ، تبدیل و ...
- بستها پایه ها ، ساپورتها ، قطعات هم بندی و اتصالات مربوط جهت نصب در موقعیت های مختلف.

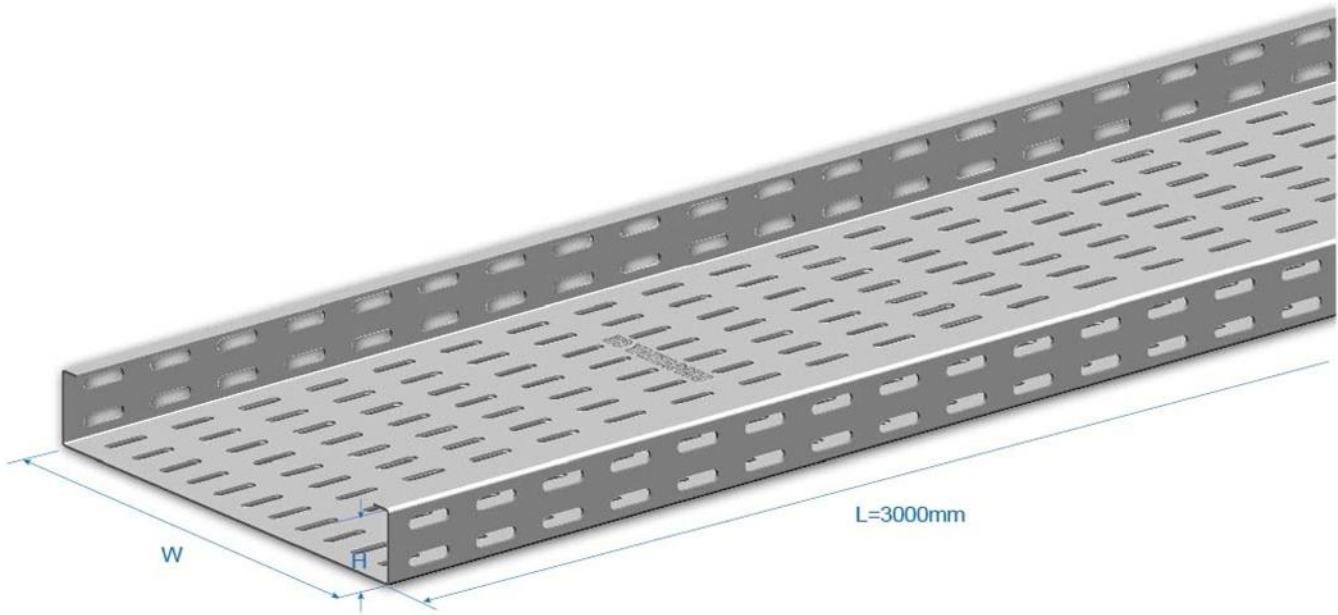

جدول سائز بندی سینی کابل:

BC2 & BC5 & BC6 Cable Tray

	Ordering Code	W (mm)	H (mm)	L (mm)
BC2	BC2-50G	50	50	3000
	BC2-100G	100	50	3000
	BC2-150G	150	50	3000
	BC2-200G	200	50	3000
	BC2-250G	250	50	3000
	BC2-300G	300	50	3000
	BC2-450G	450	50	3000
	BC2-600G	600	50	3000
BC5	BC5-75G	75	75	3000
	BC5-100G	100	75	3000
	BC5-150G	150	75	3000
	BC5-200G	200	75	3000
	BC5-250G	250	75	3000
	BC5-300G	300	75	3000
	BC5-450G	450	75	3000
	BC5-600G	600	75	3000
BC6	BC6-100G	100	100	3000
	BC6-150G	150	100	3000
	BC6-200G	200	100	3000
	BC6-250G	250	100	3000
	BC6-300G	300	100	3000
	BC6-450G	450	100	3000
	BC6-500G	500	100	3000
	BC6-600G	600	100	3000

BC2-E3 Elbow 90°

	Ordering Code	W (mm)	H (mm)
BC2-E3	BC2-E3-50G	50	50
	BC2-E3-100G	100	50
	BC2-E3-150G	150	50
	BC2-E3-200G	200	50
	BC2-E3-250G	250	50
	BC2-E3-300G	300	50
	BC2-E3-450G	450	50
	BC2-E3-600G	600	50

◆ BC5/6-E3 Elbow 90° Available



BC2-E3 Elbow 90°

BC2-T Tee

	Ordering Code	W (mm)	H (mm)
BC2-T	BC2-T-50G	50	50
	BC2-T-100G	100	50
	BC2-T-150G	150	50
	BC2-T-200G	200	50
	BC2-T-250G	250	50
	BC2-T-300G	300	50
	BC2-T-450G	450	50
	BC2-T-600G	600	50

◆ BC5/6-T Tee Available

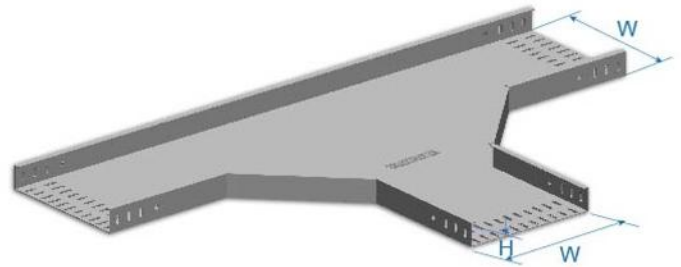

BC2-T Tee

BC2-C Cross

	Ordering Code	W (mm)	H (mm)
BC2-C	BC2-C-50G	50	50
	BC2-C-100G	100	50
	BC2-C-150G	150	50
	BC2-C-200G	200	50
	BC2-C-250G	250	50
	BC2-C-300G	300	50
	BC2-C-450G	450	50
	BC2-C-600G	600	50

◆ BC5/6-C Cross Available

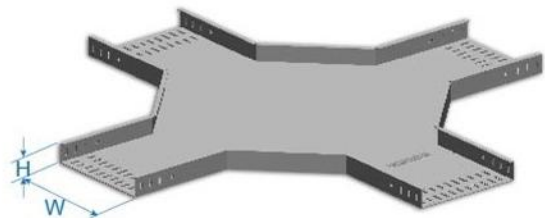

BC2-C Cross

BC2-RR Right Hand Reducer

	Ordering Code	W1 (mm)	W2 (mm)	H (mm)
BC2-RR	BC2-RR-10050G	100	50	50
	BC2-RR-15050G	150	50	50
	BC2-RR-20050G	200	50	50
	BC2-RR-150100G	150	100	50
	BC2-RR-200100G	200	100	50
	BC2-RR-250100G	250	100	50
	BC2-RR-200150G	200	150	50
	BC2-RR-300150G	300	150	50

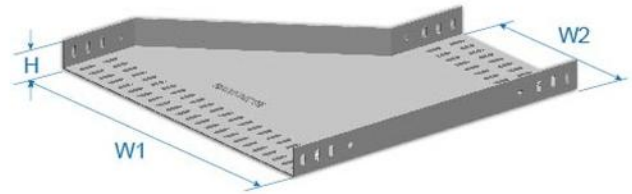

◆ BC5/6-RR Right Hand Reducer Available

BC2-RR Right Hand Reducer

BC2-LR Left Hand Reducer

	Ordering Code	W1 (mm)	W2 (mm)	H (mm)
BC2-LR	BC2-LR-10050G	100	50	50
	BC2-LR-15050G	150	50	50
	BC2-LR-20050G	200	50	50
	BC2-LR-150100G	150	100	50
	BC2-LR-200100G	200	100	50
	BC2-LR-250100G	250	100	50
	BC2-LR-200150G	200	150	50
	BC2-LR-300150G	300	150	50

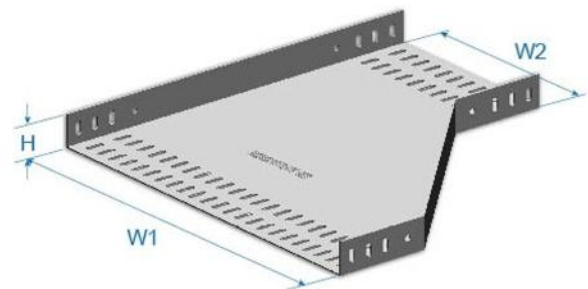

◆ BC5/6-LR Left Hand Reducer Available

BC2-LR Left Hand Reducer

BC2-BE Blind End

	Ordering Code	W (mm)	H (mm)
BC2-BE	BC2-BE-50G	50	50
	BC2-BE-100G	100	50
	BC2-BE-150G	150	50
	BC2-BE-200G	200	50
	BC2-BE-250G	250	50
	BC2-BE-300G	300	50
	BC2-BE-450G	450	50
	BC2-BE-600G	600	50

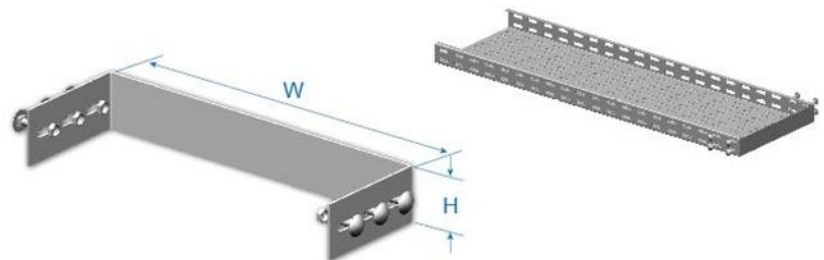

◆ BC5/6-BE Blind End Available

BC2-BE Blind End

BC2-MR Middle Reducer

	Ordering Code	W1 (mm)	W2 (mm)	H (mm)
BC2-MR	BC2-MR-10050G	100	50	50
	BC2-MR-15050G	150	50	50
	BC2-MR-20050G	200	50	50
	BC2-MR-150100G	150	100	50
	BC2-MR-200100G	200	100	50
	BC2-MR-250100G	250	100	50
	BC2-MR-200150G	200	150	50
	BC2-MR-300150G	300	150	50

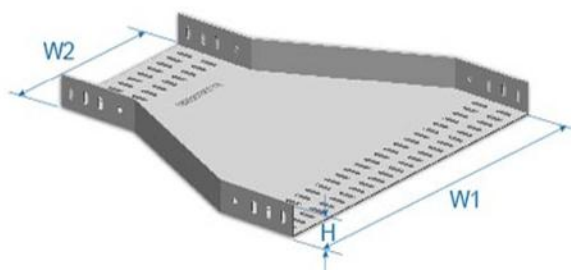

◆ BC5/6-MR Middle Reducer Available

BC2-MR Middle Reducer

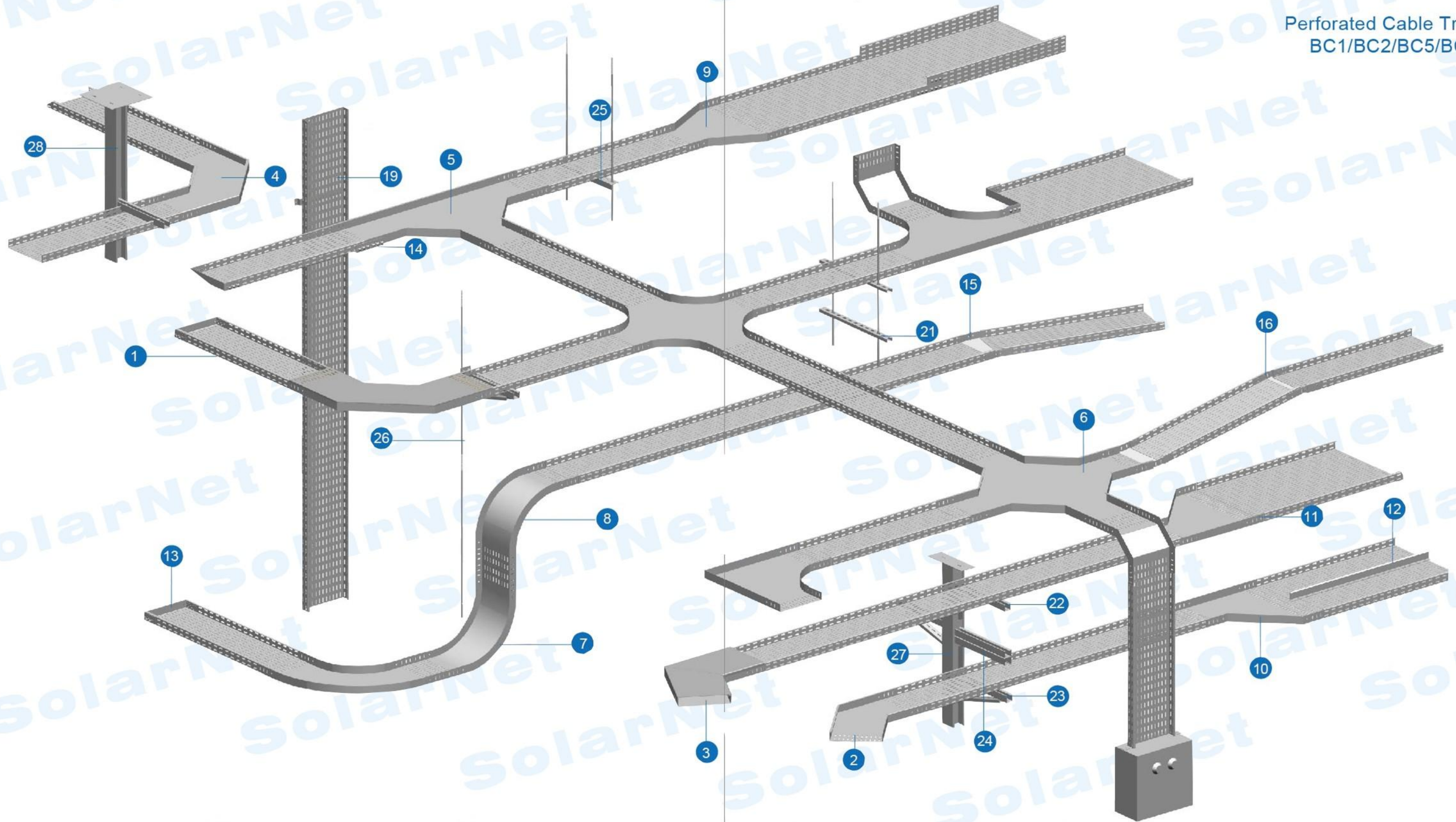

- 1 Perforated Cable Tray Straight (BC*)
- 2 Elbow 45° (BC*-E1)
- 3 Elbow 60° (BC*-E2)
- 4 Elbow 90° (BC*-E3)
- 5 Tee (BC*-T)
- 6 Cross (BC*-C)
- 7 Inside Riser (BC*-IR)

- 8 Outside Riser (BC*-OR)
- 9 Reducer (BC*-MR)
- 10 Right Hand Reducer (BC*-RR)
- 11 Left Hand Reducer (BC*-LR)
- 12 Divider (BC*-D)
- 13 Blind End (BC*-BE)
- 14 Straight Coupler (BC*-SC)

- 15 Horizontal Adjust Coupler (BC*-HAC)
- 16 Vertical Adjust Coupler (BC*-VAC)
- 17 Adjust Riser (BC*-AR)
- 18 Bolt & Nut (BN)
- 19 Under Floor Stand (UFS)
- 20 Cover Clamp (BC*-CLP)
- 21 Straight Bracket (SB)

- 22 Wall Bracket (WB)
- 23 Strengthen Bracket (STB)
- 24 Strengthening Bracket (STNB)
- 25 Angle Bar Bracket (ABB)
- 26 Treaded Rod (TR)
- 27 Ceiling Bracket (CB)
- 28 Strengthening Ceiling Bracket (SCB)

- 29 Flat Cover (BC-FSC)
- 30 Peak Cover (BC-PSC)
- 31 Elbow 45° Cover (BC-EFC)
- 32 Elbow 60° Cover (BC-ESC)
- 33 Elbow 90° Cover (BC-ENC)
- 34 Tee Cover (BC-TC)
- 35 Cross Cover (BC-CC)

- 36 Inside Riser Cover (BC-IRC)
- 37 Outside Riser Cover (BC-ORC)
- 38 Reducer Cover (BC-RC)
- 39 Right Hand Reducer Cover (BC-RRC)
- 40 Left Hand Reducer Cover (BC-LRC)

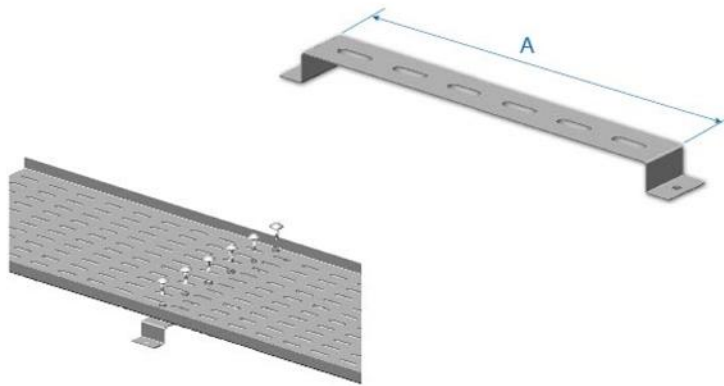

UFS Under Floor Stand

UFS Under Floor Stand

Ordering Code	A (mm)
UFS-50G	50
UFS-100G	100
UFS-150G	150
UFS-200G	200
UFS-250G	250
UFS-300G	300
UFS-450G	450
UFS-600G	600

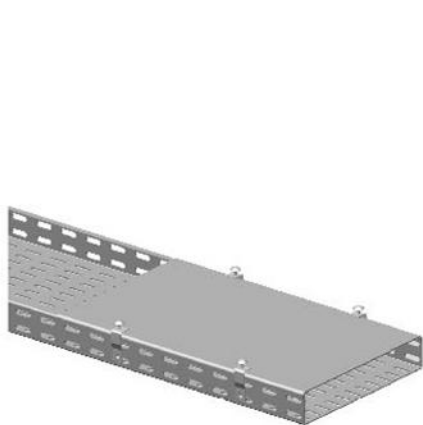

B**-CC Cover Clamp

B**-CC Cover Clamp

Ordering Code
B**-CC

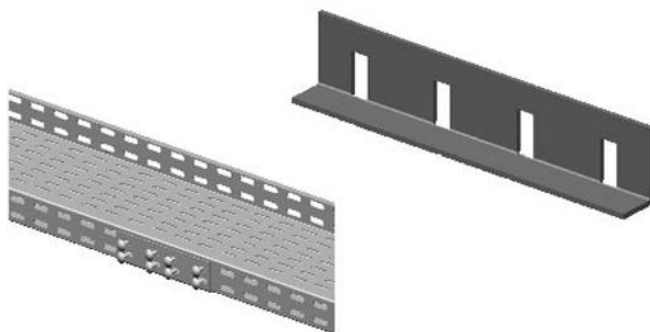

BC2/5/6-SC Straight Coupler

BC2/5/6-SC Straight Coupler

Ordering Code
BC*-SC

FSC Flat Cover

Ordering Code	W (mm)	L (mm)
FSC-50G	50	3000
FSC-100G	100	3000
FSC-150G	150	3000
FSC-200G	200	3000
FSC-250G	250	3000
FSC-300G	300	3000
FSC-450G	450	3000
FSC-600G	600	3000

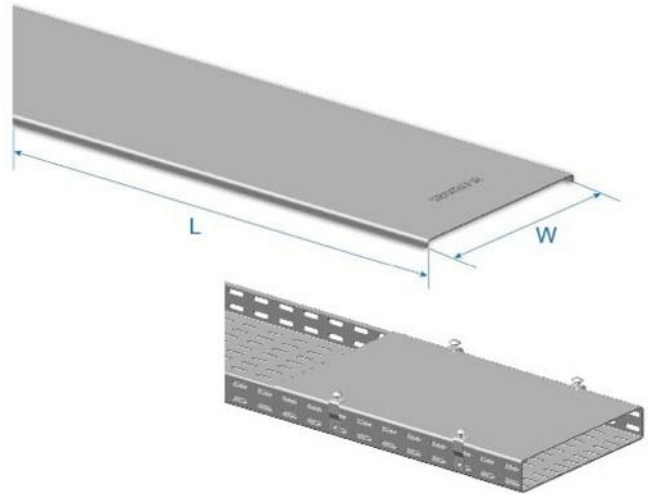

FSC Flat Cover

ENC Elbow 90° Cover

Ordering Code	W (mm)
ENC-50G	50
ENC-100G	100
ENC-150G	150
ENC-200G	200
ENC-250G	250
ENC-300G	300
ENC-450G	450
ENC-600G	600



ENC Elbow 90° Cover

TC Tee Cover

Ordering Code	W (mm)
TC-50G	50
TC-100G	100
TC-150G	150
TC-200G	200
TC-250G	250
TC-300G	300
TC-450G	450
TC-600G	600

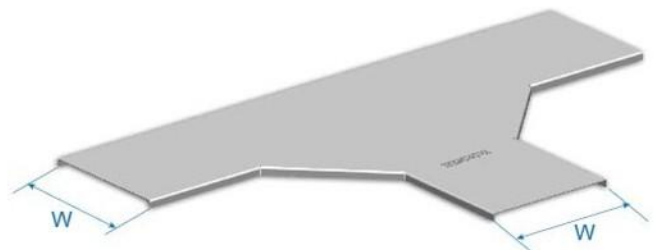

TC Tee Cover

ABB Angle Bar Bracket

Ordering Code	W (mm)	A (mm)
ABB-50	50	150
ABB-100	100	200
ABB-150	150	250
ABB-200	200	300
ABB-250	250	350
ABB-300	300	400
ABB-450	450	550
ABB-600	600	700



ABB Angle Bar Bracket

WB Wall Bracket

Ordering Code	W (mm)	A (mm)
WB-50	50	100
WB-100	100	150
WB-150	150	200
WB-200	200	250
WB-250	250	300
WB-300	300	350
WB-450	450	500
WB-600	600	650



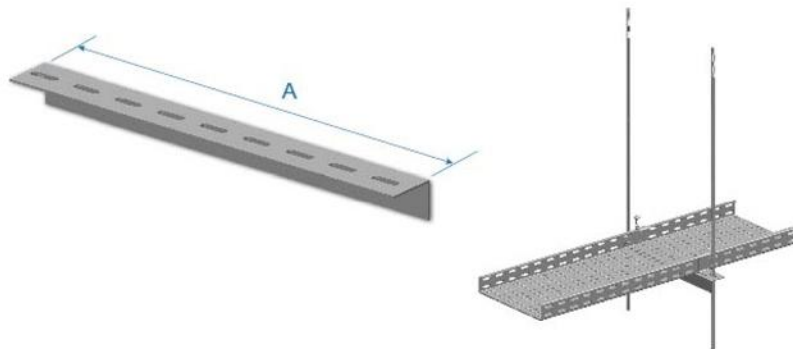
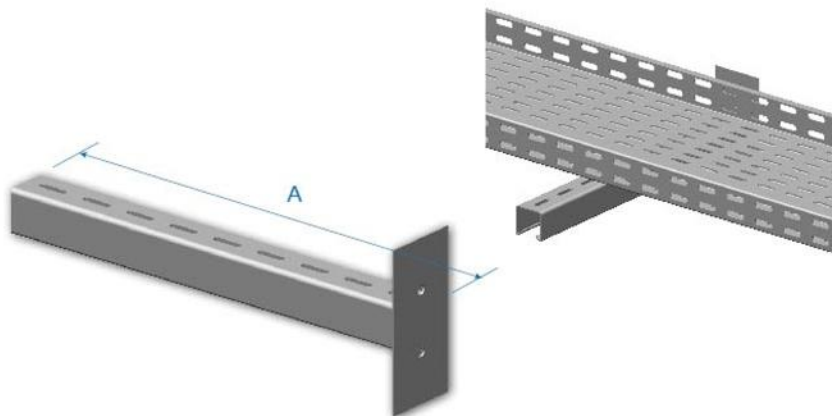





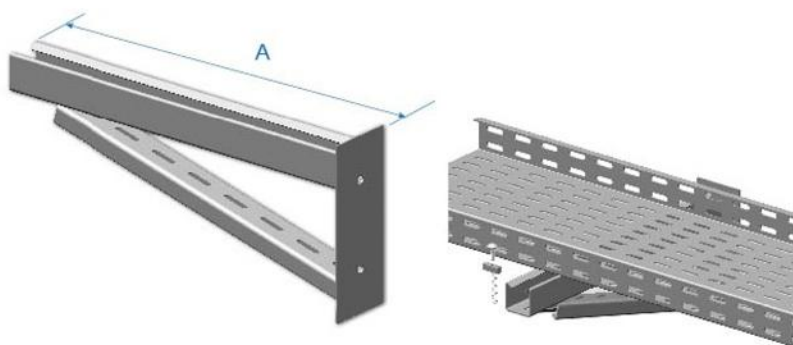



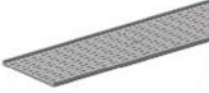





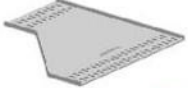

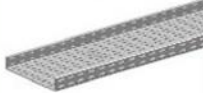

















WB Wall Bracket

STB Strengthen Bracket

Ordering Code	W (mm)	A (mm)
STB-50	50	100
STB-100	100	150
STB-150	150	200
STB-200	200	250
STB-250	250	300
STB-300	300	350
STB-450	450	500
STB-600	600	650

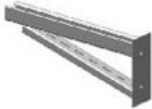
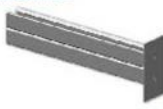

STB Strengthen Bracket

BC1 Cable Tray  P/05	BC1-E3 Elbow 90°  P/06	BC1-T Tee  P/06	BC1-C Cross  P/06	BC1-IR Inside Riser  P/06	BC1-OR Outside Riser  P/07
BC1-MR Middle Reducer  P/07	BC1-RR Right Hand Reducer  P/07	BC1-LR Left Hand Reducer  P/07	BC2 & BC5 & BC6 Cable Tray  P/08	BC2-E3 Elbow 90°  P/09	BC2-T Tee  P/09
BC2-C Cross  P/09	BC2-IR Inside Riser  P/10	BC2-OR Outside Riser  P/10	BC2-MR Middle Reducer  P/10	BC2-RR Right Hand Reducer  P/11	BC2-LR Left Hand Reducer  P/11
BC2-BE Blind End  P/11	BC2-AR Adjust Riser  P/11	BC2/5/6-D Divider  P/12	BC2/5/6-SC Straight Coupler  P/12	BC2/5/6-HAC Horizontal Adjust Coupler  P/12	BC2/5/6-VAC Vertical Adjust Coupler  P/12
FSC Flat Cover  P/13	ENC Elbow 90° Cover  P/13	TC Tee Cover  P/13	CC Cross Cover  P/14	IRC Inside Riser Cover  P/14	ORC Outside Riser Cover  P/14
MRC Middle Reducer Cover  P/15	RRC Right Hand Reducer Cover  P/15	LRC Left Hand Reducer Cover  P/15	UFS Under Floor Stand  P/16	B**-CC Cover Clamp  P/16	SB Straight Bracket  P/16
ABB Angle Bar Bracket  P/17	WB Wall Bracket  P/17	STB Strengthen Bracket  P/17	STNB Strengthening Bracket  P/18	CB Ceiling Bracket  P/18	SCB Strengthening Ceiling Bracket  P/18

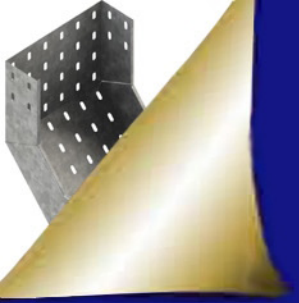

فناوران سولار شبکه

انواع سینی کابل با پوشش گالوانیزه سرد و گالوانیزه گرم
به همراه قطعات و اتصالات استاندارد
جهت بستر کابل های برق و شبکه (دیتا) در تأسیسات ساختمانهای
اداری ، تجاری و مسکونی ، انبارها ، نیروگاه ها ، صنایع و کارخانه ها و ...



آدرس:

نارمک ، خیابان شهید مدنی ، جنب مترو فدک ، مجتمع تجاری پالمیرا ، واحد ۶۰۸

تلفن/فکس: ۰۲۱-۷۷۸۵۱۶۹۶

همراه: ۰۹۱۲۶۱۷۹۳۸۳ ، ۰۹۱۰۴۹۴۵۴۴۸

ایمیل: Solarshabakeh@gmail.com